

GuK

Technische Gummi und Kunststoffe GmbH

Fassaden-Profile

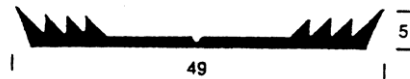
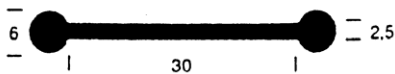

GuK Technische Gummi und Kunststoffe GmbH
Buckower Chaussee 69 - 70
12277 Berlin

Telefon (030) 72 39 29 - 0
Telefax (030) 72 39 29 99

E-Mail: info@guk-berlin.de
Internet: www.guk.de



■ Fassaden-Profile

aus Vollgummi bzw. Weich-PVC

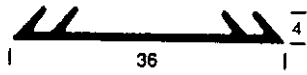

05 F 0119

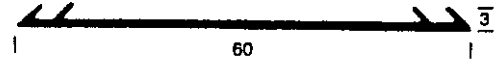

05 F 0120

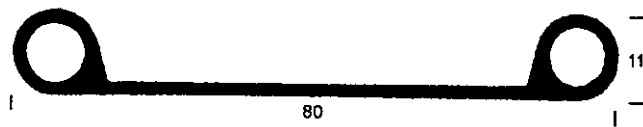

05 F 0220

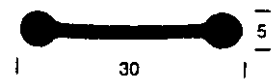

05 F 0287

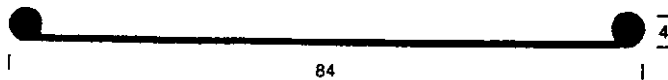

05 F 0310

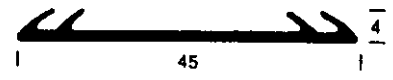

05 F 0330

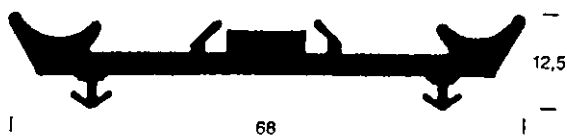

05 F 0336

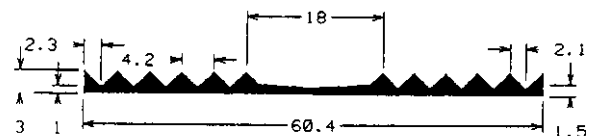

05 F 0358

■ Fassaden-Profile

aus Vollgummi bzw. Weich-PVC

2

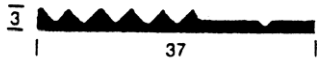

05 F 0361

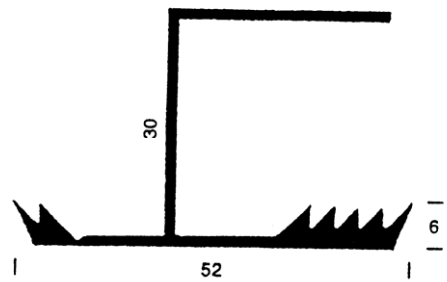

05 F 0399

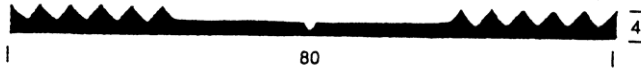

05 F 0400

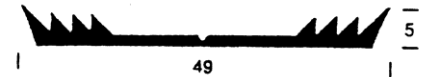

05 F 0414

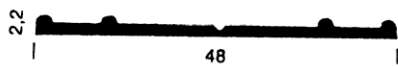

05 F 0417

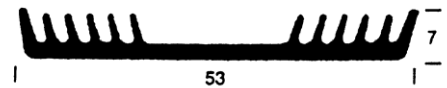

05 F 0419



05 F 0457

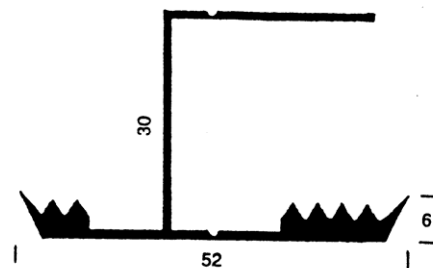

05 F 0459

■ Fassaden-Profile

aus Vollgummi bzw. Weich-PVC

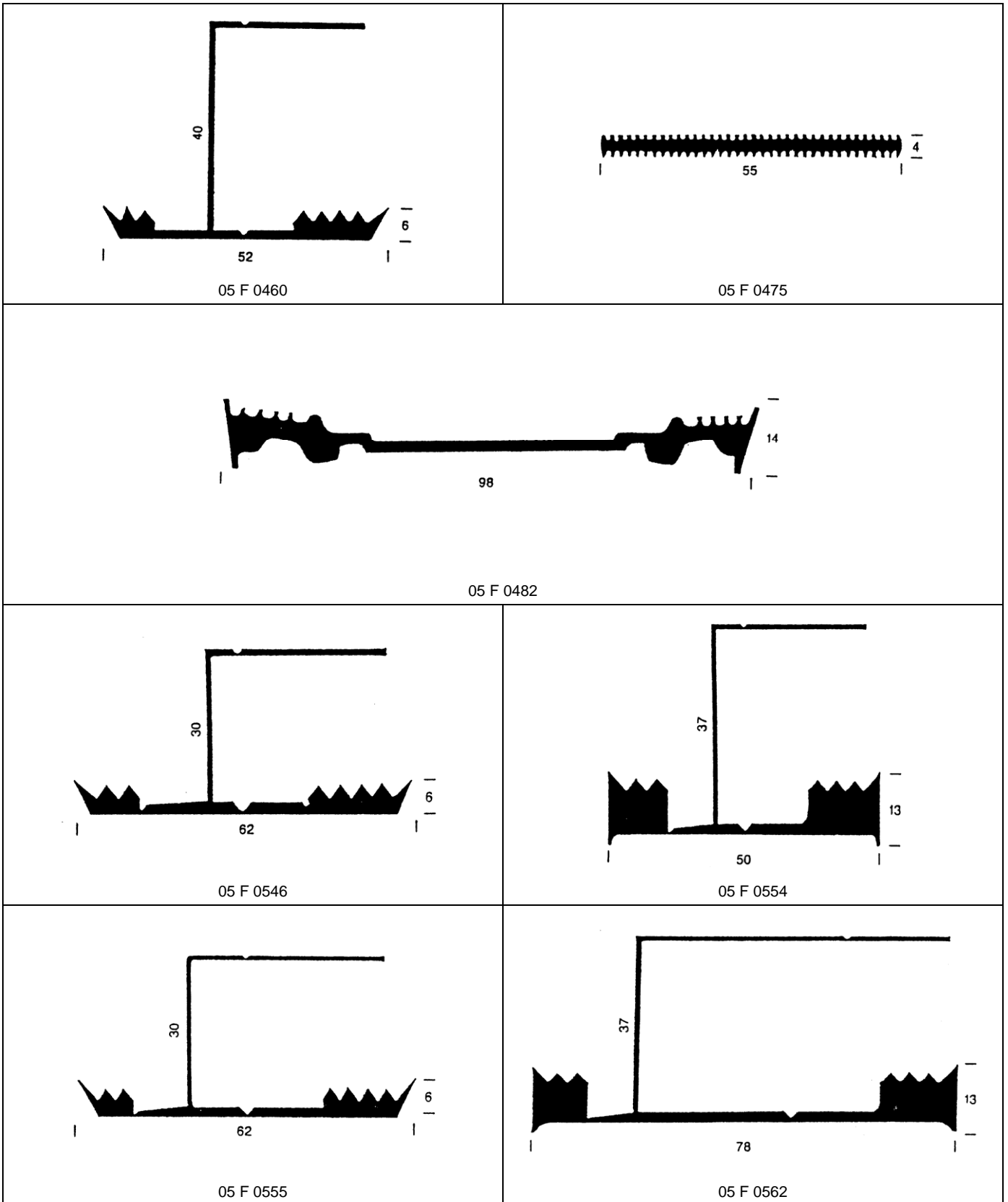

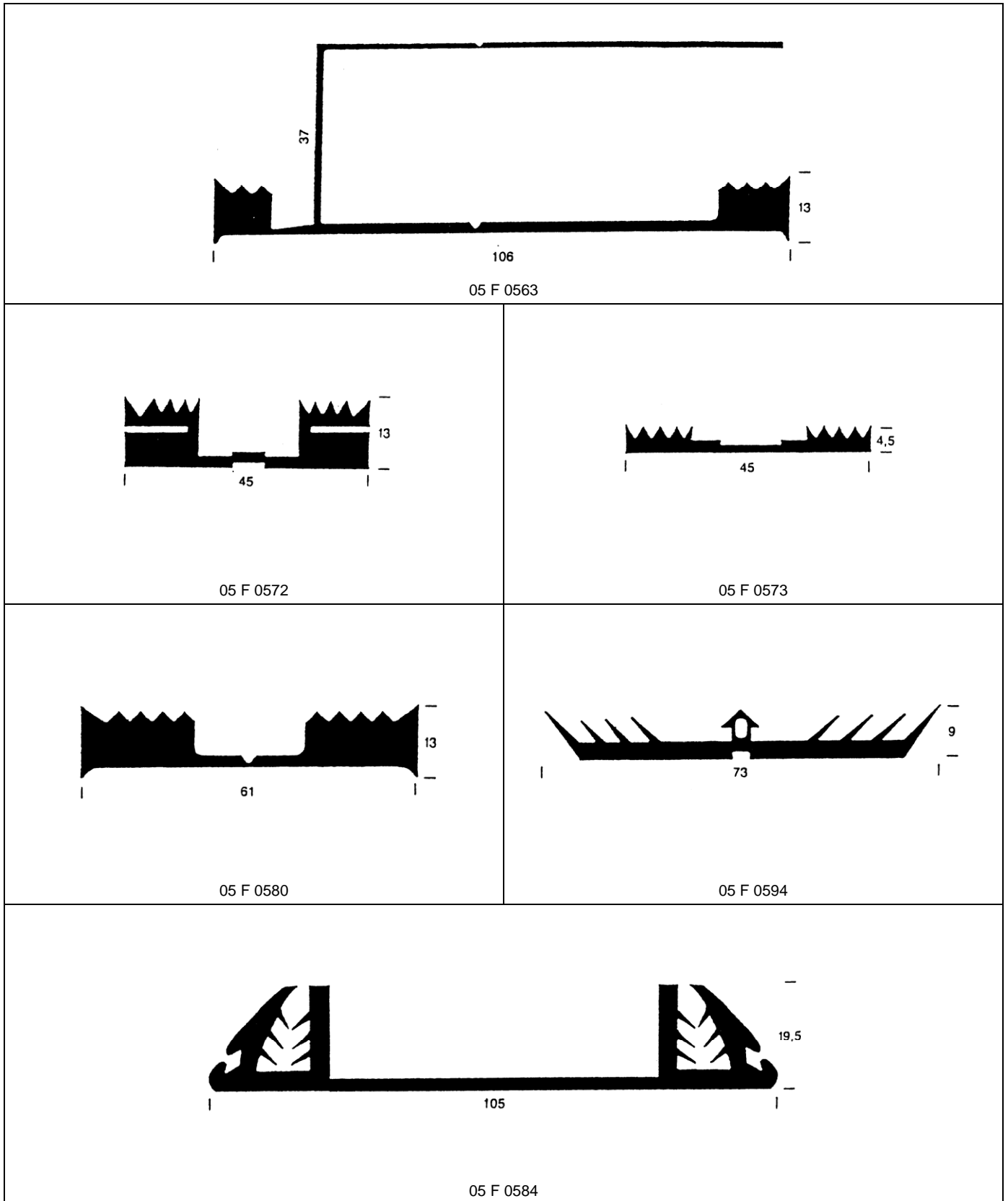

■ Fassaden-Profile

aus Vollgummi bzw. Weich-PVC





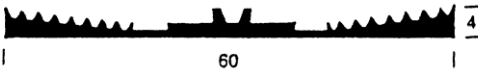
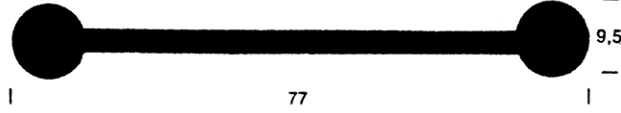
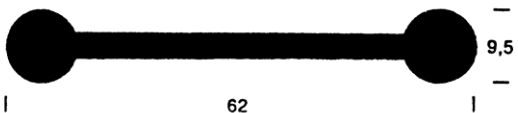
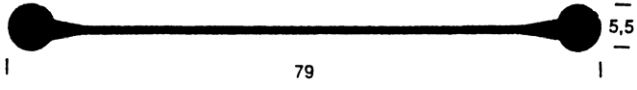
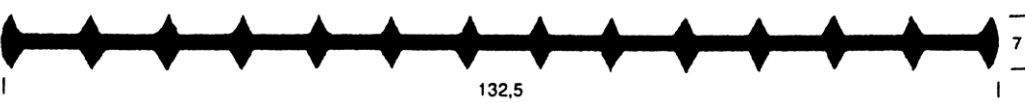

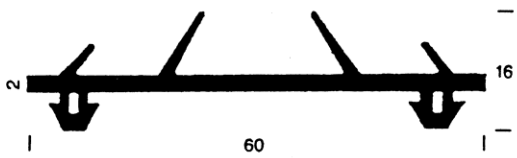
■ Fassaden-Profile

aus Vollgummi bzw. Weich-PVC

 <p>05 F 0595</p>	 <p>05 F 0699</p>
 <p>05 F 0700</p>	 <p>05 F 0701</p>
 <p>05 F 0702</p>	
 <p>05 F 0703</p>	 <p>05 F 0704</p>

■ Fassaden-Profile

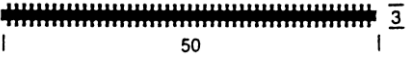
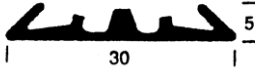
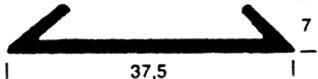
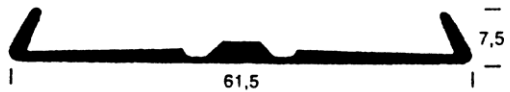
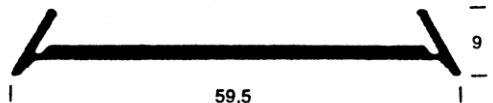
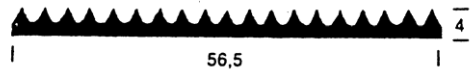
aus Vollgummi bzw. Weich-PVC

 <p>05 F 0705</p>	 <p>05 F 0706</p>	
 <p>05 F 0707</p>	 <p>05 F 0708</p>	 <p>05 F 0709</p>
 <p>05 F 0710</p>	 <p>05 F 0711</p>	
 <p>05 F 0712</p>	 <p>05 F 0713</p>	

■ Fassaden-Profile

aus Vollgummi bzw. Weich-PVC

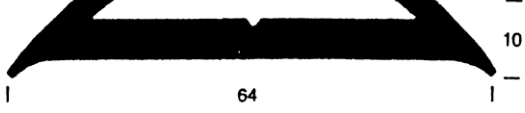
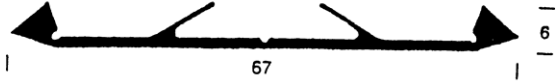
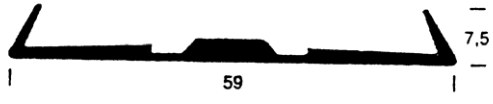
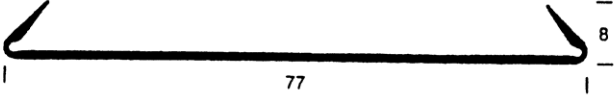
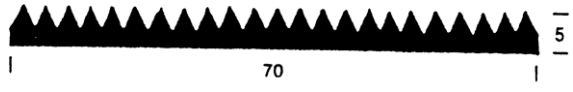
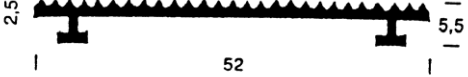
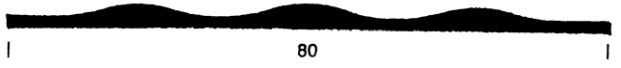
 <p>55</p> <p>12,5</p> <p>05 F 0714</p>	 <p>64</p> <p>10</p> <p>05 F 0715</p>
 <p>67</p> <p>6</p> <p>05 F 0716</p>	 <p>59</p> <p>7,5</p> <p>05 F 0717</p>
 <p>77</p> <p>8</p> <p>05 F 0718</p>	 <p>70</p> <p>5</p> <p>05 F 0719</p>
 <p>52</p> <p>2,5</p> <p>5,5</p> <p>05 F 0720</p>	 <p>80</p> <p>3</p> <p>05 F 0721</p>

■ Fassaden-Profile

aus Vollgummi bzw. Weich-PVC

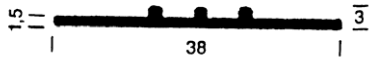

05 F 0722



05 F 0724



05 F 0725

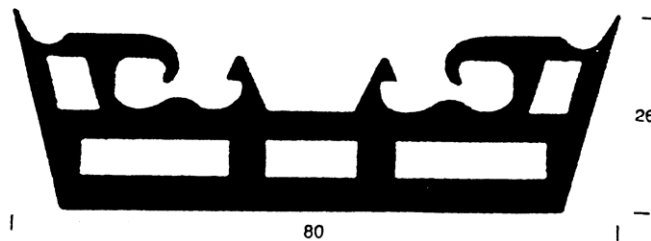

05 F 0726

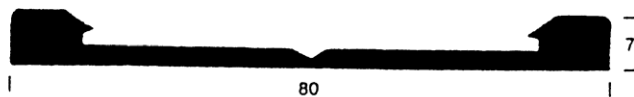

05 F 0727

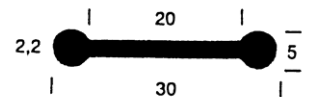

05 F 0837

■ Fassaden-Profile

aus Vollgummi bzw. Weich-PVC

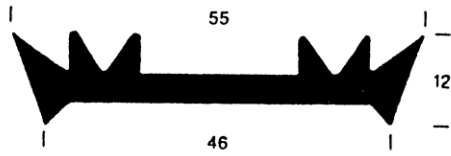

05 F 0916

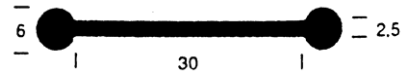

05 F 0922

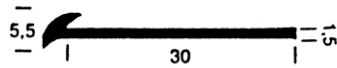

05 F 0925

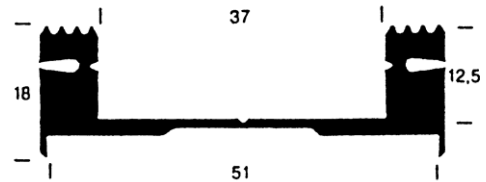

05 F 0929

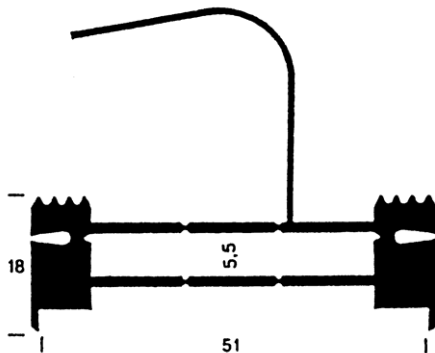

05 F 0930

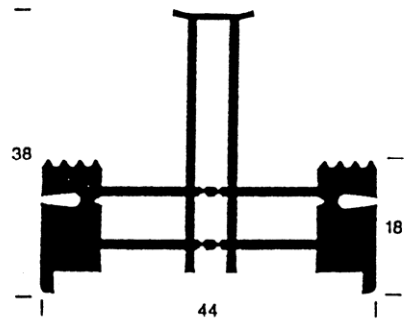

05 F 0981

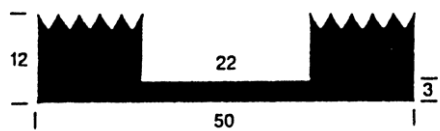

05 F 0984

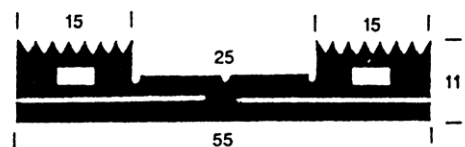

05 F 1140

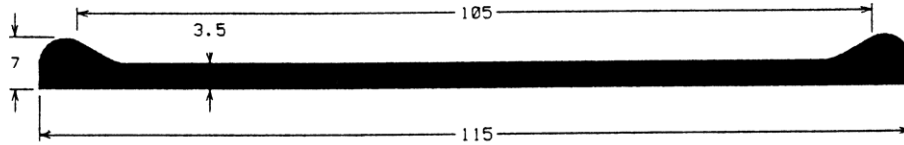

05 F 1244

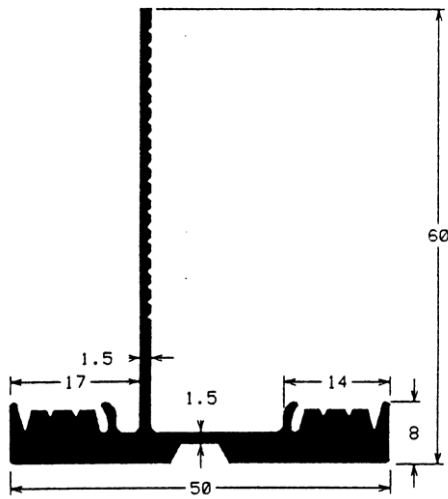

05 F 1246

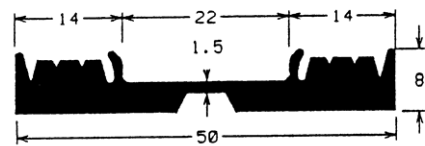

05 F 1247

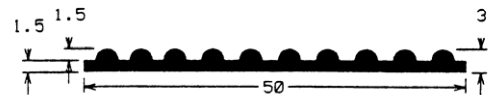

05 F 1287

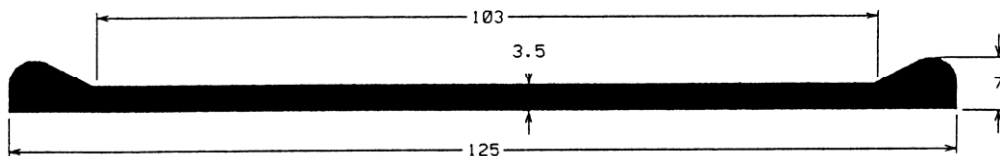

05 F 1271

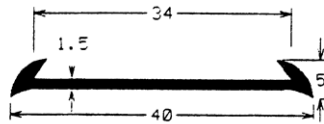

05 F 1294

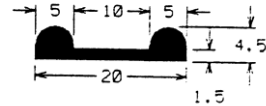

05 F 1313

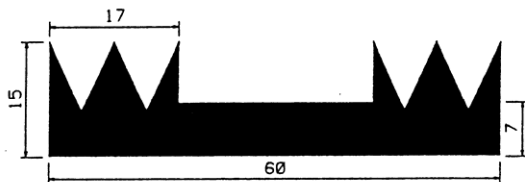

05 F 1359

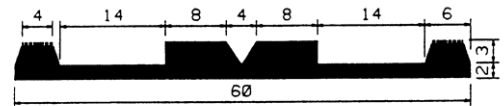

05 F 1387

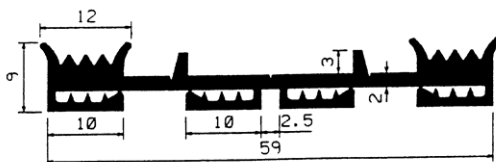

05 F 1410

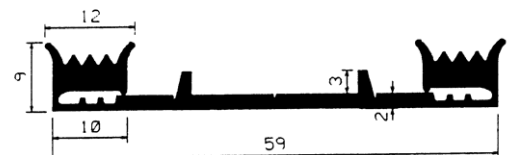

05 F 1411

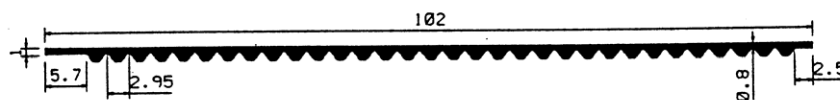

05 F 1420